

Multi-View Camera

VDMW-2123EX



Features

- 2Mega CMOS Sensor x 3ea
- 1080P(30fps)
- EX-SDI(2.0/1.0), HD-SDI
- 3.6mm Fixed Lens x 3ea
(Option 2.5/3.6/6.0/8.0mm)
- Weatherproof

Dimension ※scale : NS (mm)

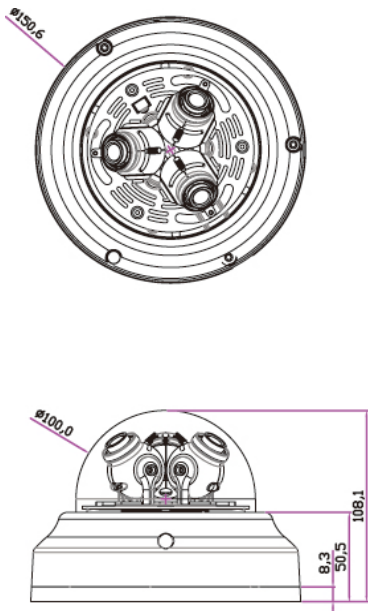

Specifications

Model	VDMW-2123EX
TV System	DIGITAL / EX-SDI
Image Sensor	1/2.9" 2M CMOS Sensor x 3ea
Total Pixels	1956(H) x 1266(V) approx. 2.47M pixels
Scanning System	PROGRESSIVE
Sync. Mode	INTERNAL
Resolution	more 1000 TV Lines
Video Output	EX-SDI(2.0/1.0), HD-SDI
White Balance	ATW/AWB/AWC->SET/INDOOR/OUTDOOR/MANUAL
Shutter Speed	MANUAL/AUTO/FLK
LENS	3.6mm Fixed Lens x 3ea (Option 2.5/3.6/6.0/8.0mm)
On Screen Display	Built-In
Display Mode	Full Screen, PIP, Split Screen mode available
Video Adjustment	Brightness, Sharpness, Contrast
Remote Control	Infrared Remote Controller
RS 485 Control	Pelco-D
Video Output Terminal	BNC Connector
Power Input Terminal	Φ 5.5 Jack
Operation Temperature	-10°C ~50°C (14°F ~ 122°F)
Power Consumption	DC 12V(±10%), (Max. 8Watts)
Dimension(mm)	Φ150.6 x 108.1